

ML4830N15

Maximum Power Point Tracking ML Series



Main Features

1. Advanced double-peak or multiple-peak tracking technology. When the panel has a shadow block or a part of the panel is damaged, I-V curve shows multiple peaks. The solar charge controller can still accurately track the maximum power point.
2. Built-in algorithm for maximum power tracking. This significantly raises energy utilization efficiency of photovoltaic systems, with charging efficiency 15% ~ 20% higher than traditional PWM solar charge controllers.
3. Combination of multiple tracking algorithms that can track the optimum working point of I-V curve accurately in a very short period of time.
4. MPPT tracking efficiency can be as high as 99.9%.
5. Advanced digital power technology, with circuit energy conversion efficiency as high as 98%.
6. Supporting charging procedures of gel batteries, sealed batteries, open batteries, lithium batteries and other types of batteries.
7. Current-limiting charging mode. When the power of a solar panel is too large, and the charging current is greater than rated current, the solar charge controller automatically reduces charging power, thereby making the solar panel work at rated charging current.
8. Supporting the start of capacitive load instantaneous large current.
9. Supporting automatic identification of battery voltage.
10. LED indicator of malfunction, buzzer alarm, and liquid crystal display of abnormal information. This helps users identify system failures.
11. Supporting historical data storage for up to 5 years.
12. LCD screen display function. The display enables users to view equipment operation data and status, and modify controller parameters at the same time.

Installation and Wiring

Warning: Explosion risk. Do not install the solar charge controller and open type cell in the same closed space. Do not install in closed place where battery gas may gather.

Warning: High pressure danger. Photovoltaic array may generate very high open circuit voltage. Before wire connection, disconnect the breaker or insurance. Be careful in the process of wiring.

Attention: When installing a solar charge controller, make sure there is enough air flowing through the cooling fin of the controller. Leave a space of at least 150 mm up and down the solar charge controller to ensure natural heat loss through convection. If installed within a closed cabinet, ensure reliable heat dissipation through the cabinet body.

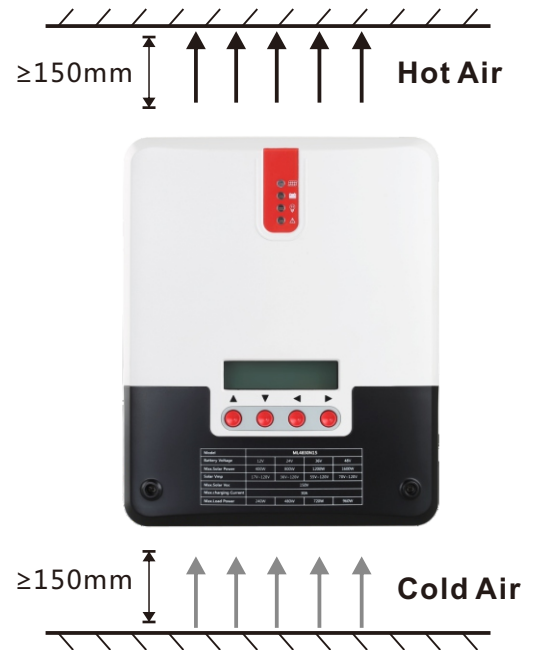

Figure 2-1 Installation and Heat Dissipation

Step 1: Selecting an installation location.

Avoid installing solar charge controller in a place where there is direct sunlight, high temperature or easy water inflow. Ensure the surrounding area of the solar charge controller is well ventilated.

Step 2:

First place installation guide plate at proper position, then use pen and mark on installation location, drill four installation holes at marked places of suitable size, and fixe with screw.

Step 3: Fix the solar charge controller.

On the installation surface, use a pen to mark the positions of four mounting holes, and then move away solar charge controller. Drill four size-suitable mounting holes at four marked positions, and fix screws in advance, align fixing holes of solar charge controller to on the four fixed screws, and then hang it up.

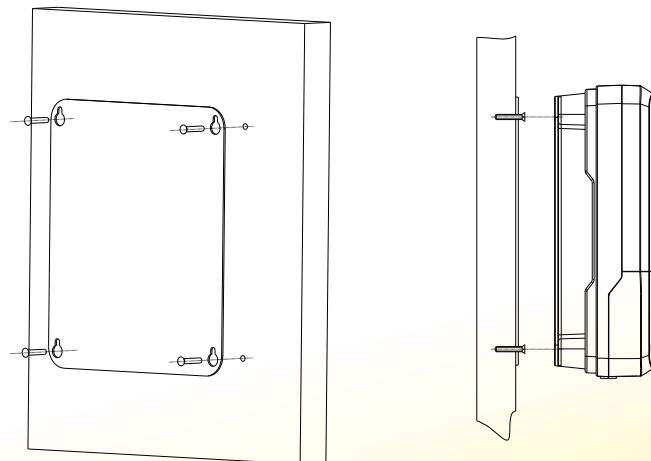

Figure 2-2 Fix the solar charge controller

Wiring

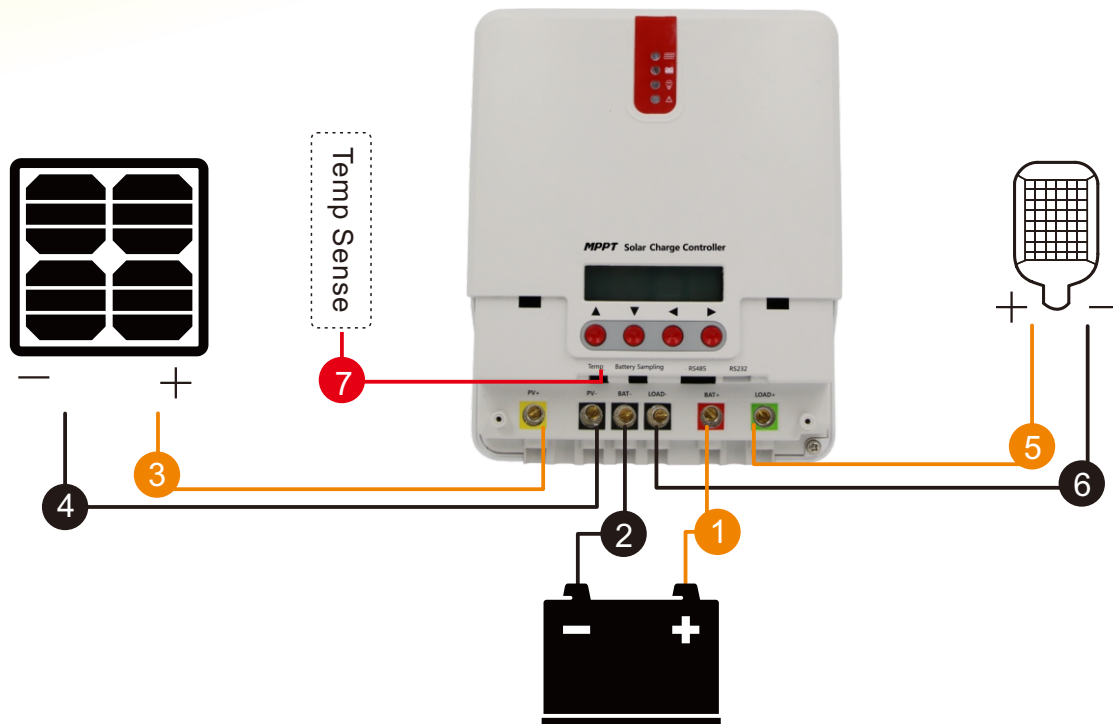
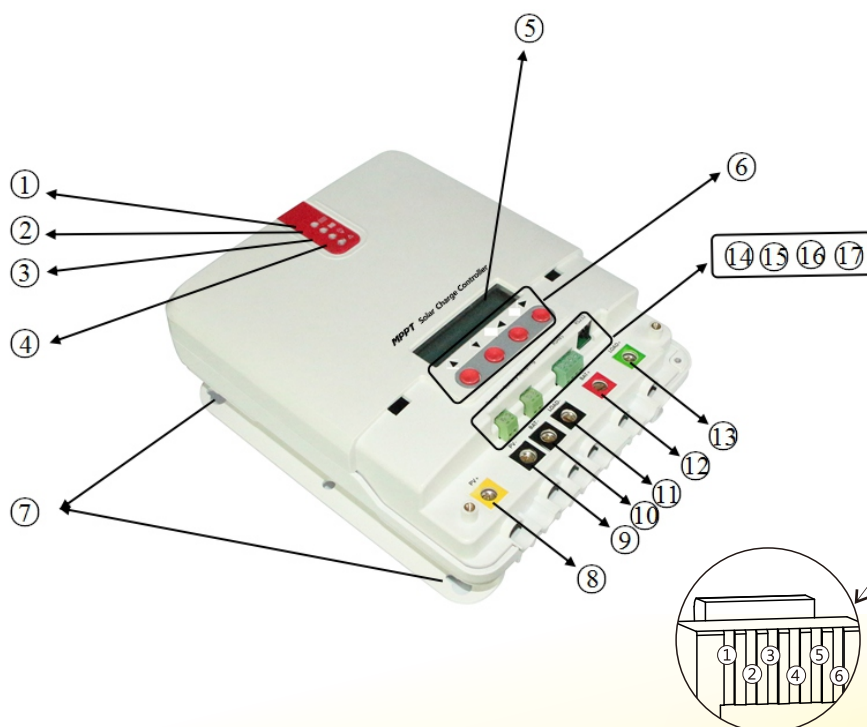
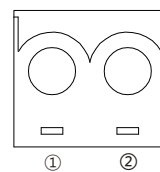

Figure 2-3 Wiring

Exterior



15 Battery Sampling



ITEM	DEFINITION
①	-
②	+

16 RS485

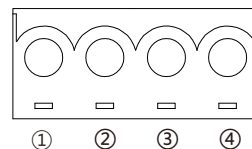

ITEM	DEFINITION
①	12V
②	GND
③	D-
④	D+

17 Controller Communication Port RJ12 (6 Pins)

RS232

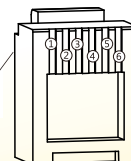

ITEM	DEFINITION
①	Transmit Terminal TX
②	Receive Terminal RX
③	Power Source GND / Signal GND
④	Power Source GND / Singal GND
⑤	Power Source +
⑥	Power Source +

Electrical Parameter

Parameter Name	Parameter Value
Model	ML4830N15
System Voltage	12V/24V/36V/48V Auto
No-Load Loss	0.7 W ~ 1.2W
Battery Voltage	9V ~ 70V
Max Solar Energy Input Voltage	<150V
Max Power Point Voltage Scope	Battery Voltage +2V ~ 120V
Rated Charging Current	30A
Rated Load Current	20A
Max capacitive load capacity	10000uF
PV System Max Input Power	400W/12V 800W/24V 1200W/36V 1600W/48V
Conversion Efficiency	≤98%
MPPT Tracking Efficiency	>99%
Temperature compensation coefficient	-3mv/°C/2V (Default)
Working Temperature	-35°C ~ +45°C
Protection Level	IP32
Weight	2.3Kg
Max Wiring Size	25 mm ²
Communication Mode	RS485, RS232
Altitude	≤ 3000m
Product Size	226*182*81mm